

ΔΙΑΤΟΜΕΣ ΚΑΙ ΣΥΝΔΕΣΜΟΛΟΓΙΑ

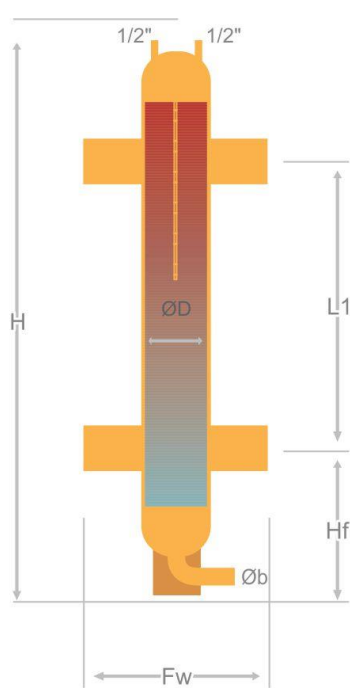

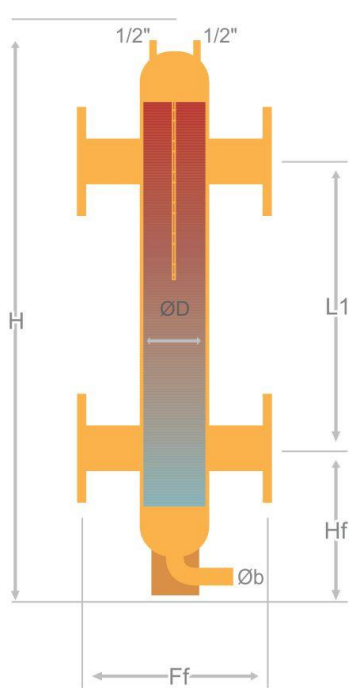
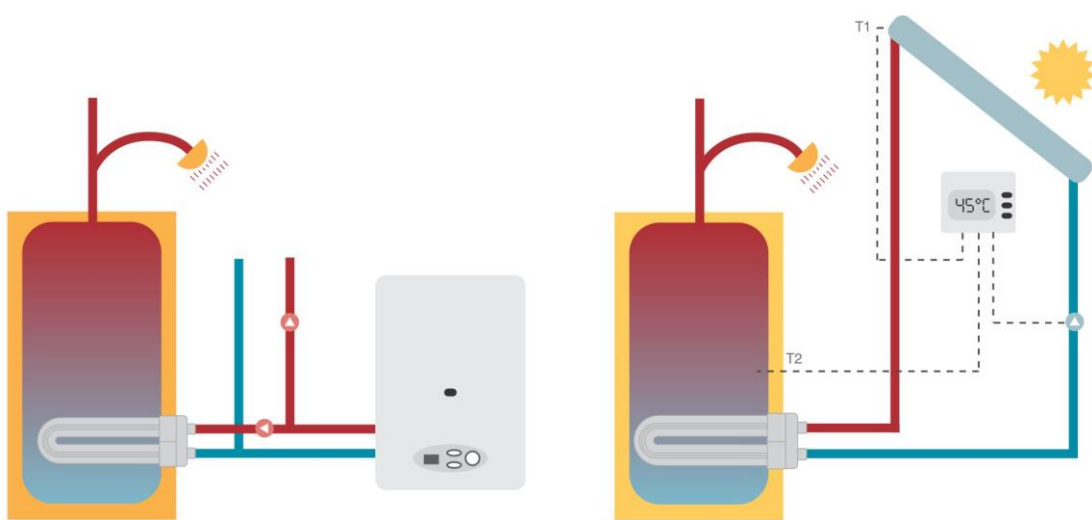
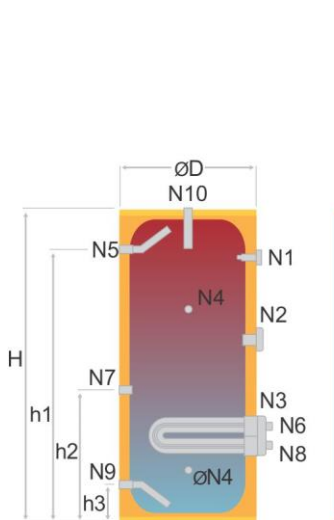
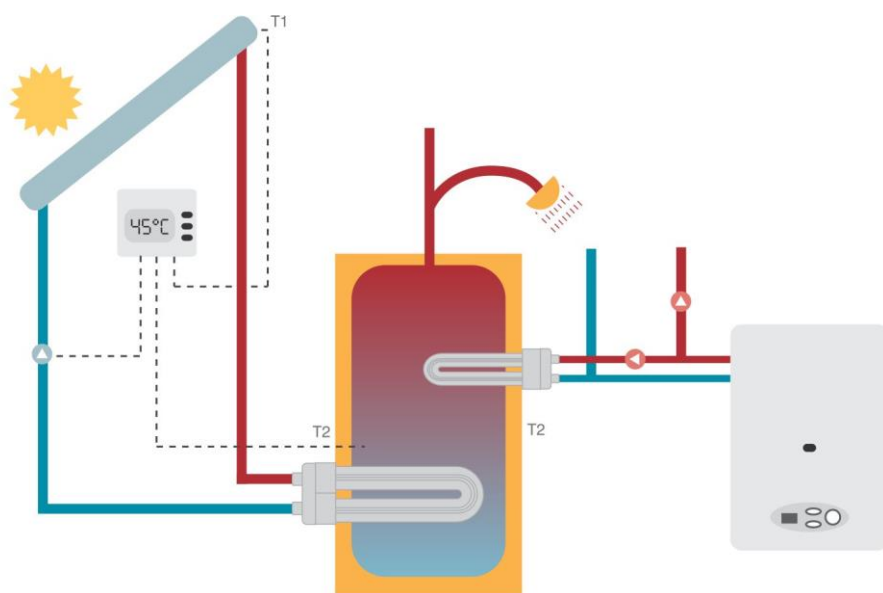
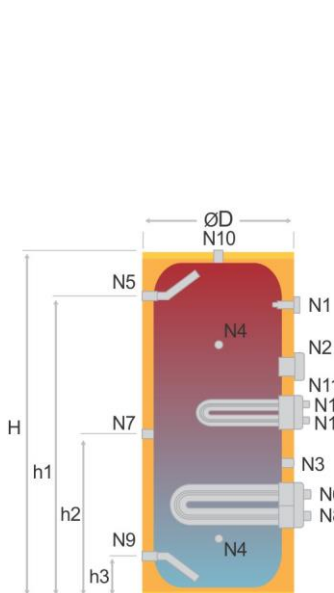
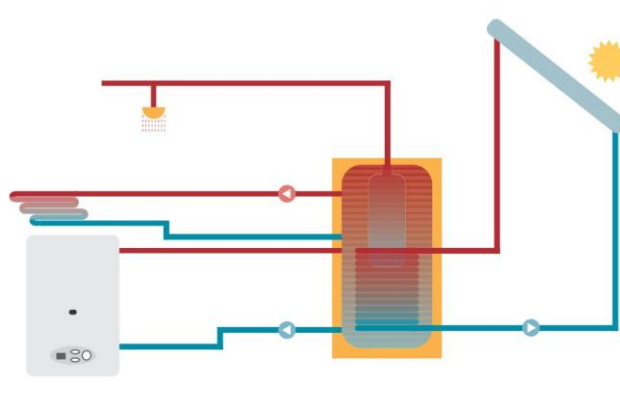
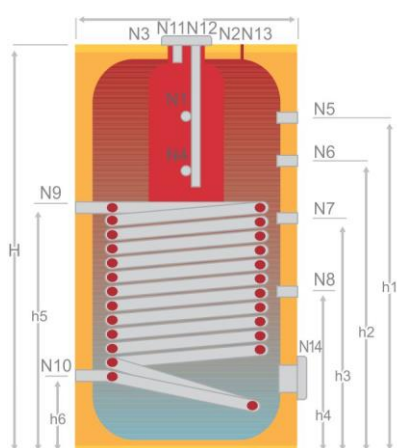
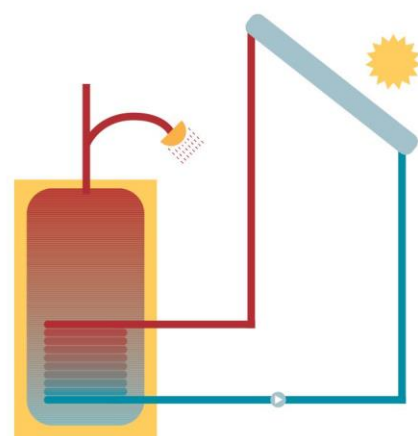
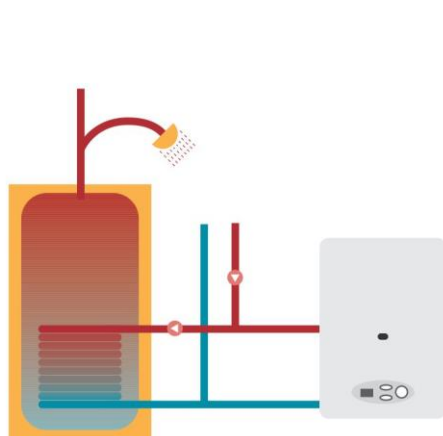
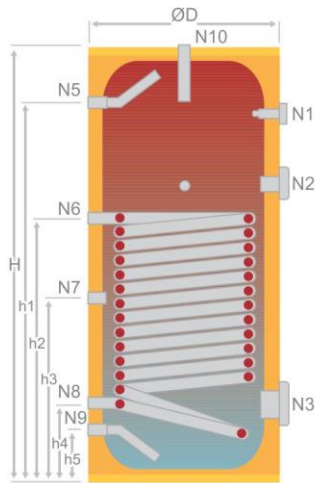
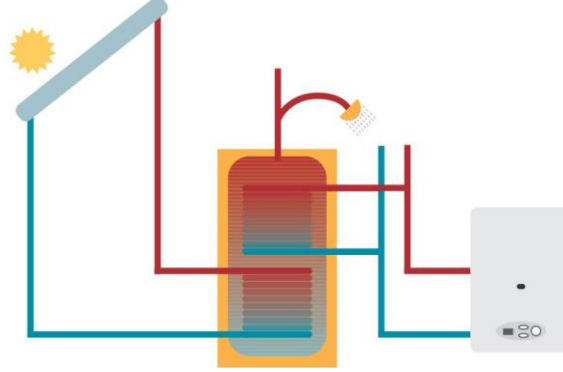
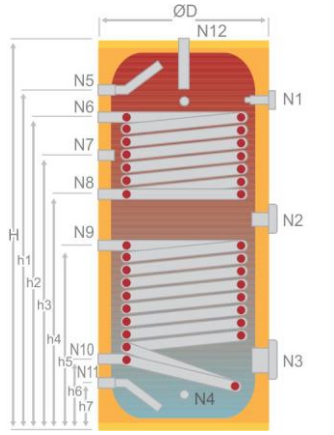
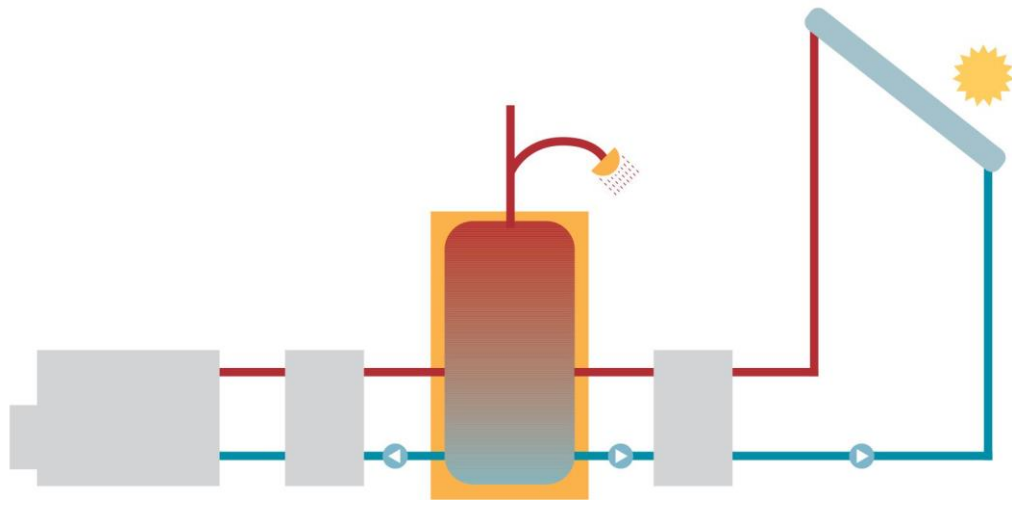
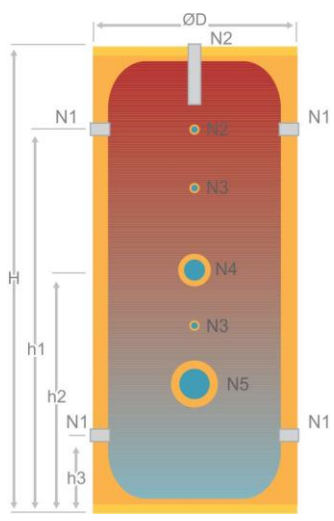
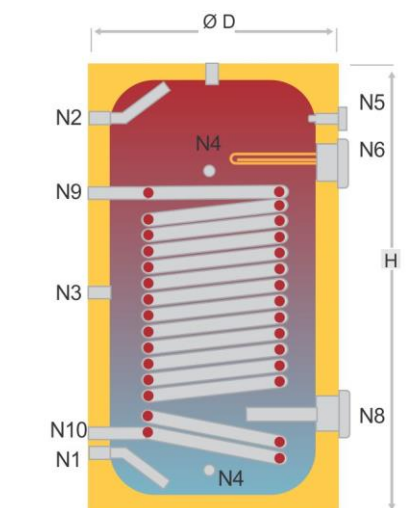
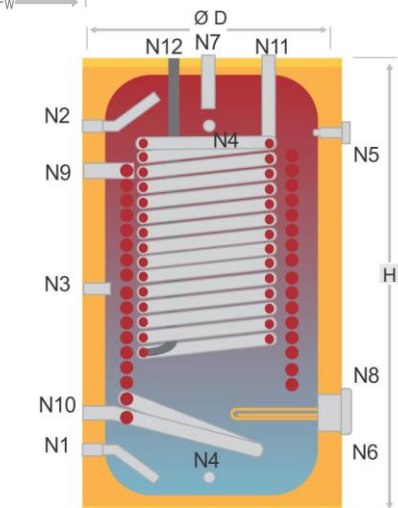
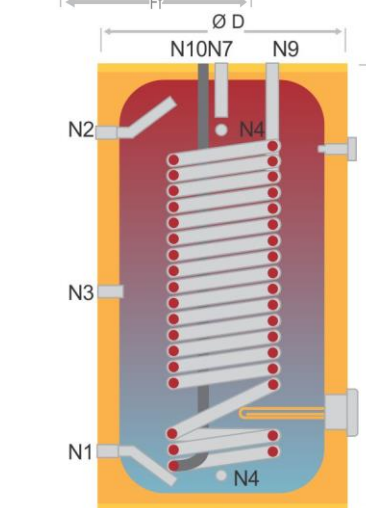
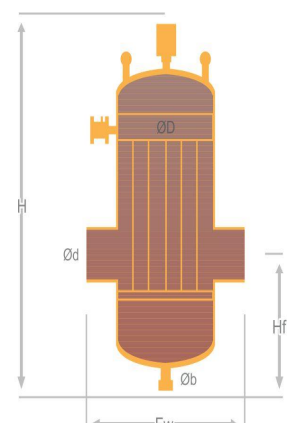
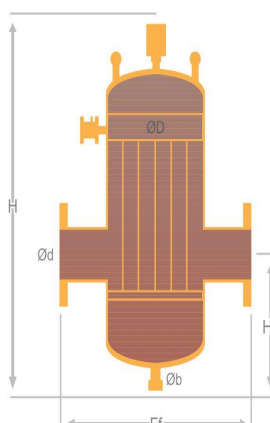
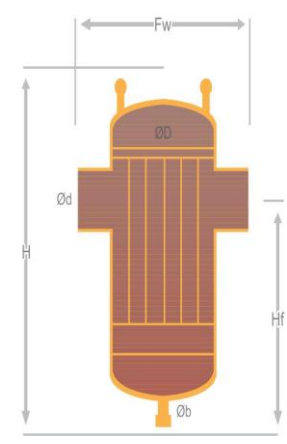
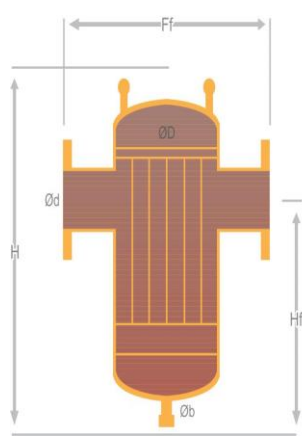
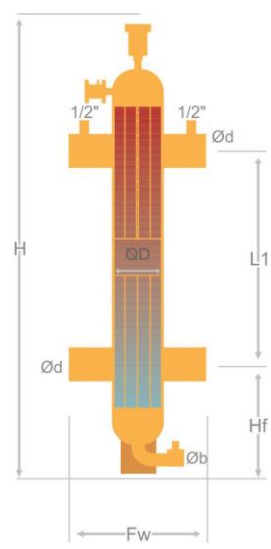
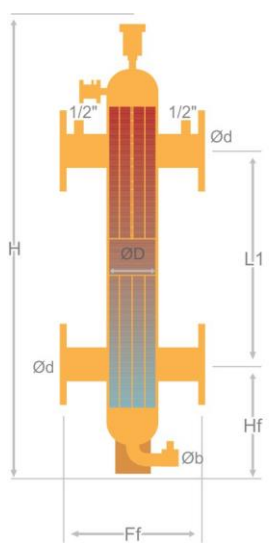
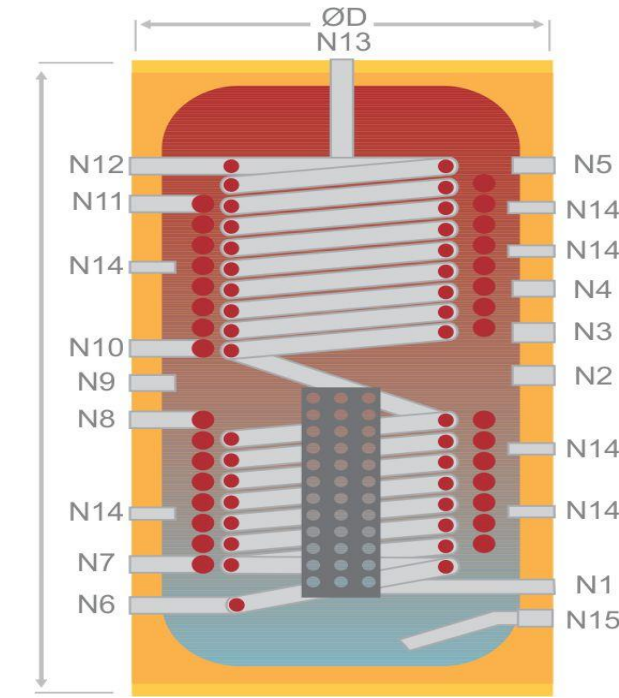
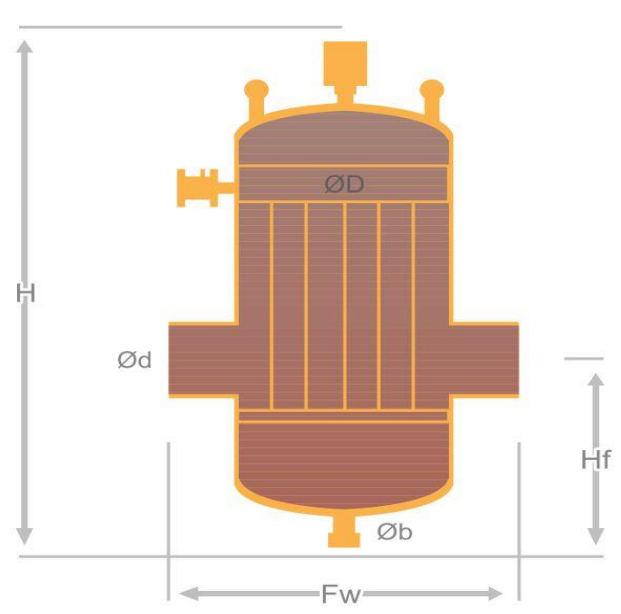
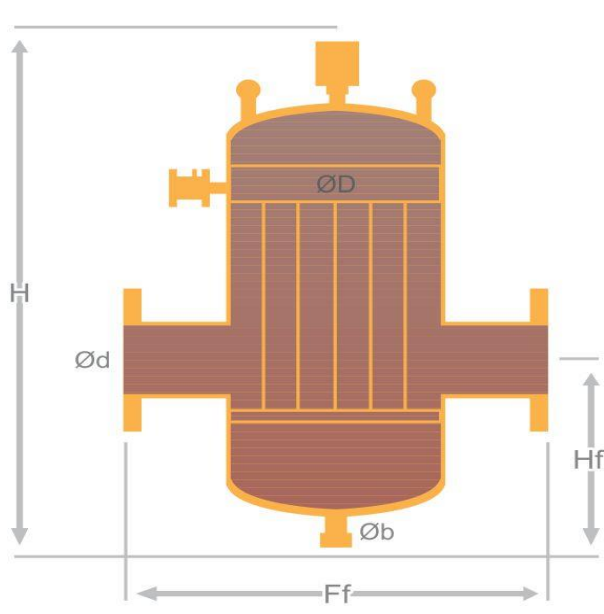
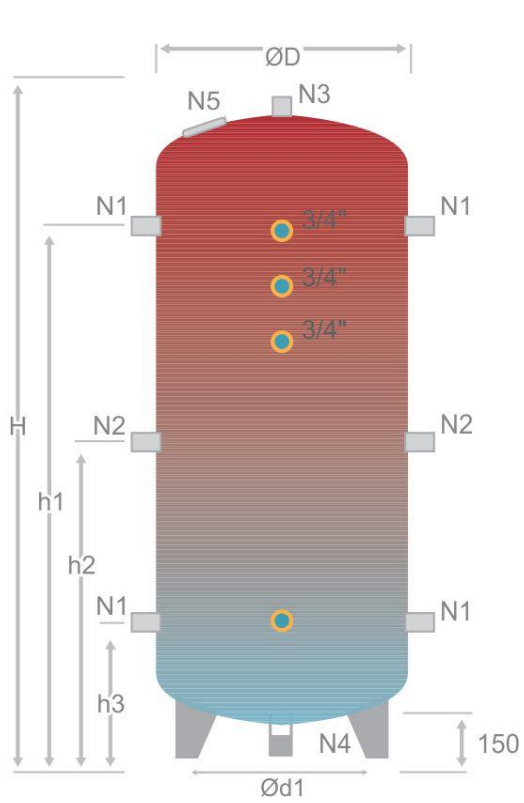

KXS SINGLE SERPANTINE WATER HEATER ( 100 lt - 200 lt - 300 lt - 500 lt )

KXD DOUBLE SERPANTINE WATER HEATER ( 200 lt - 300 lt - 500 lt )

KXS SINGLE SERPANTINE WATER HEATER ( 1000 lt - 2000 lt )